



Operating Instructions
in compliance with
Pressure Equipment Directive 2014/68/EU
and
Pressure Equipment (Safety) Regulation 2016,
UK Statutory Instrument 2016 No. 1105

Rotalock Adapter



Please read these operating instructions carefully to ensure a safe operation and keep the same for further use.



Contents

Safety.....	3
Authorized personnel.....	3
Residual dangers.....	3
Symbols used for safety information	3
General safety information	4
Other information.....	4
Description of adapter	5
Types.....	5
Operating principle Rotalock screw connection	6
Arrangement and designation of Service connections	6
Product description.....	6
Identification	6
Technical parameters.....	7
Design Features	7
Transport and Storage.....	8
Mounting.....	9
Principles	9
Mounting preparation.....	9
Connecting pipe / system	9
Commissioning.....	12
Principles	12
Steps of commissioning.....	12
Operation, Maintenance and Repair	13
Principles	13
Handling the service connections.....	13
Repairs	13
Dismantling and Disposal.....	14
Principles	14

Safety

The Rotalock Adapter, hereinafter referred to as adapter, is designed for use in refrigeration/air conditioning systems referred to as systems hereinafter. It may only be put into service if installed into the system unchanged in accordance with these instructions and as a whole is compliance with the statutory provisions.

The adapter incorporates state-of-the-art technology and has been built according to the applicable regulations. Great value has been set upon the user's safety.

These operating instructions are integral part of the contract and shall be kept throughout the entire life of the adapter.

Authorized personnel

Only trained and instructed personnel shall be allowed to do any work on the adapter and system. As regards the qualification and expertise of the personnel the applicable rules and guidelines shall apply.





Residual dangers

Unavoidable residual dangers may emanate from the adapter. Every person working on this device shall therefore carefully read these instructions.

To be observed are for example:

- the generally accepted safety regulations,
- EC directives,
- Norms (e.g. EN 378) and all national provisions.





Symbols used for safety information

	DANGER! Instructions on preventing imminent serious danger to persons. Imminent most serious injuries or death as a possible consequence. Any non-observance may lead to an immediate failure of the adapter.
	WARNING! Instructions on preventing potential serious hazard to persons. Avoidable serious to very serious injuries or death as a possible consequence. Any non-observance can cause the adapter to fail.
	CAUTION! Instructions on preventing a minor hazard to persons. Minor, reversible injuries cannot be excluded. Any non-observance may lead to a medium-term failure of the adapter.
	ATTENTION! Instructions on preventing potential hazard to equipment. Minor, reversible injuries cannot be excluded. Any non-observance may lead to a medium-term failure of the adapter.

General safety information

These operating instructions are based on the safety requirements of EN 378-2 and EN 12284.

Instructions to prevent hazards in all cycles of service life:

	DANGER! Risk of bursting if operated beyond the technical parameters. Most serious injuries and immediate system failure possible. Observe the technical parameters.
	WARNING! Damage due to improper handling. Serious injuries and system failure possible. Never use the adapter as transport, lifting or lashing point.
	WARNING! Any non-observance of the instructions may cause the adapter to fail. Avoidable serious to very serious injuries or death possible. Installation, operation and maintenance by authorized personnel only.
	WARNING! Risk of service fluid to be released. Depending on the kind of service fluid serious to very serious injuries or death possible as a consequence. Wear personal protective equipment (e.g. respirators, gloves).
	CAUTION! Very cold or very hot surface temperatures possible. Frostbites/burns possible. Wear personal protective equipment (e.g. gloves, protective clothes).

Other information

The information contained herein represents to the best of our belief our knowledge at the time when these instructions were prepared. It shall serve as code of practice to ensure a safe handling of the adapter in transport, storage, installation, commissioning, maintenance and dismantling/disposal. A final decision as to whether the adapter suits the purpose is to be taken by the user. This information shall not be deemed a warranty of quality.

Any modification of the adapter and operation under other than the prescribed parameters shall not be allowed and will result in the loss of the conformity declaration and all liability claims.

Description of adapter

Types

Durchgangsform
Straight version
(IG)

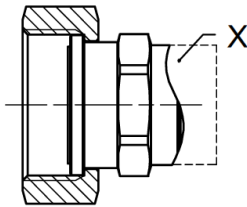

Durchgangsform
Straight version
(AG)

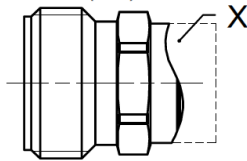

Winkelform
Angle version
(IG)

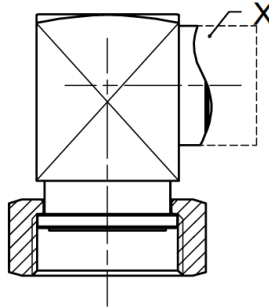

T - Form
T - version
(IG)

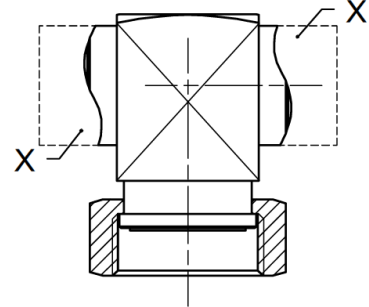

Variants of connection "X"

A

Lötanschluss
Solder connection
ODS

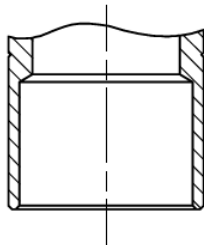

B

Stumpfschweiß-
anschluss
Butt weld connection
WB und W/ODS

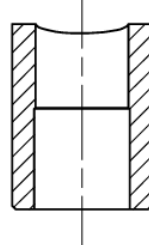

C

Flanschanschluss
Flange connection

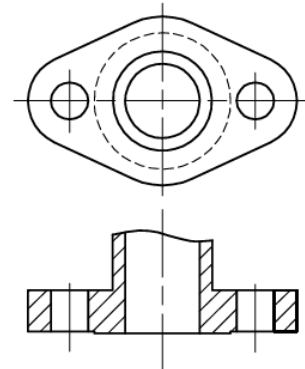

D

Rotalockanschluss
Rotalock connection
RLM / RLF

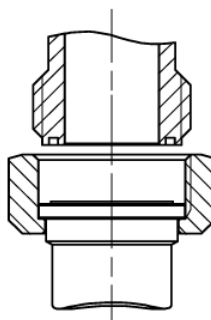

E

NPTF Gewinde/Thread
IG NPTF / AG NPTF

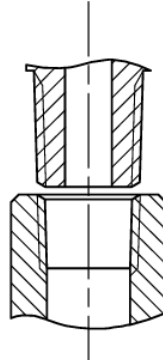

F

G Gewinde/Thread
IG G / AG G

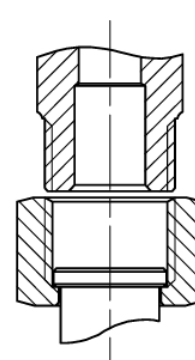

Installation dimensions can be gathered from the AWA product catalogue and technical documents respectively. The connecting options A through F are explained in more detail in "Design features".

Operating principle Rotalock screw connection

The Rotalock screw connection consists of 3 components:

- Adapter with female thread, "RLF" in short
- PTFE seal washer
- Adapter with male thread, "RLM" in short

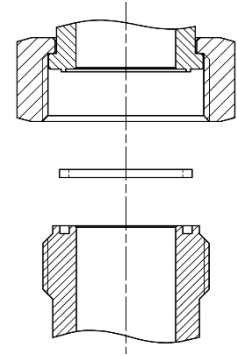

Arrangement and designation of Service connections

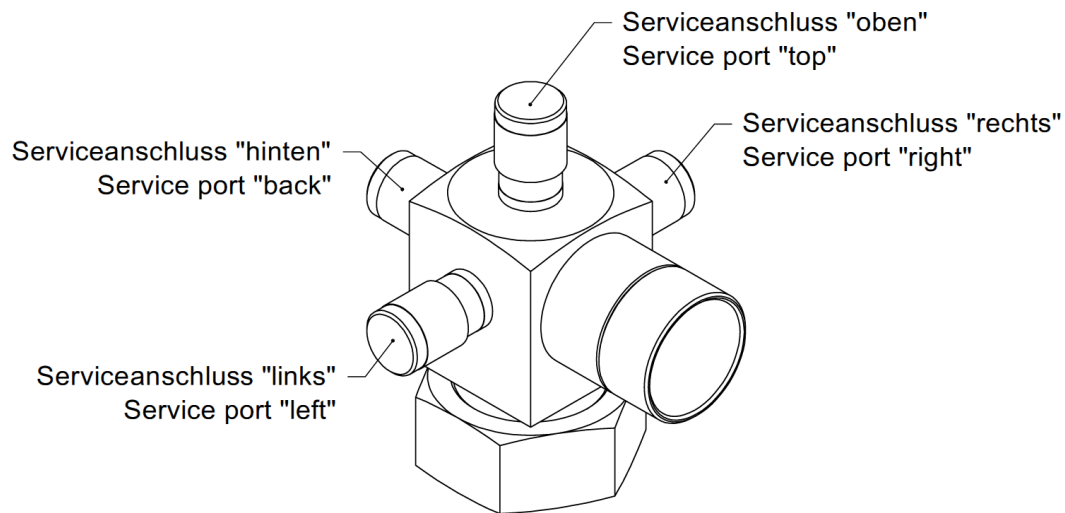

Product description

The adapter is a component designed for refrigeration and air-conditioning systems with the help of which a joint can be disconnected based on a groove-and-tongue system. A clamping of the PTFE seal washer is achieved by tightening of the screw connection.

Any flow direction can be chosen.

The adapter is in compliance with EN 12284, the Pressure Equipment Directive 2014/68/EU and the Pressure Equipment (Safety) Regulation 2016, UK Statutory Instrument 2016 No. 1105.

Identification

The adapter is marked in accordance with EN 12284 by lettering:

- Manufacturer's logo
- AWA parts number
- Coded year of manufacture
- Maximum allowable pressure PS in bar

Technical parameters

Allowable pressure / temperature / service fluids:

Maximum allowable pressure PS: As indicated in the technical documents.
Allowable temperature TS: As indicated in the technical documents.
Permitted service fluids: Refrigerants acc. to EN 378-1 (2016):
As indicated in the technical documents.

Leakage test:

according to DIN 8964-3 (<4.1 g/a R-134a at 10bar)

Strength test:

according to EN 12284 at 1.43-fold PS

Cleanliness of interior:

according to DIN 8964-1

Classification pursuant to Pressure Equipment Directive 2014/68/EU and PE(S)R 2016:

The Adapter is a component for pressure equipment.

Design Features

- The material of the adapter components and the manufacturing method are selected in conformity with the EN 12284, the Pressure Equipment Directive 2014/68/EU and the Pressure Equipment (Safety) Regulation 2016 thus guaranteeing the reliability for the operating range indicated.
- The adapters are made of one of the material given below:
 - “Steel” - The adapters are made of steel components, if necessary connected with each other by high-strength and high-density copper brazing or by welding and subsequent electroplated coating. The latter provides for corrosion protection until installation if transported and stored in dry condition.
 - “Stainless steel” - The adapters are made of stainless steel components 1.4301 if necessary connected with each other by high-strength and high-density copper brazing or by welding.
 - “Brass” – The adapters (only straight version with male thread) are made of brass 2.0401.
- Types of connection:

Because of the design principle, the inlets and outlets of the adapter can have different connections as well as positions or distances to each other.

Connection "A" – Brazed capillary connection to render a brazed joint with copper pipes according to EN 12735-1 for dia. 6 to 54mm and relevant inch dimensions. Designed as connection for insertion of a copper pipe (ODS) or insertion of a brazed fitting (ODM).

Abbreviated designation: (W /) ODS xx or ODM xx (xx stands for relevant size in mm or inch).

Connection "B" – Welded connection for use of pipes according to EN 10216 and relevant inch-type dimensions. Designed as butt-welded connection (W or WB) or plug-in welded connection (WS).

Abbreviated designation: WB xx, W xx and WS xx (xx stands for relevant size in mm or inch).

Connection "C" – Detachable flange connection designed as 2-hole oval flange (hole distance 35 to 70mm) or 4-hole rectangular flange (hole distance 40 to 85mm) for use of a metal bead or fibre gasket.

Abbreviated designation: F xx (xx stands for relevant size in mm or inch)

Connection "D" – Detachable threaded connection according to Rotalock principle using a PTFE seal ring designed as connection with male (RLM) or female (RLF) thread. Optimal results of this screw joint are achieved when no other than AWA components are used.

Abbreviated designation: RLM xx and RLF xx resp. (xx stands for relevant size in mm or inch)

Connection "E" – Detachable threaded connection with NPTF thread acc. to ANSI B1.20.3, designed as connection with male (AG NPTF) or female thread (IG NPTF).

Abbreviated designation: AG NPTF xx and IG NPTF xx resp. (xx stands for relevant size in inch).

Connection "F" – Detachable threaded connection with cylindrical pipe thread acc. ISO 228, designed as connection with male (AG G) or female (IG G) thread for use of a metal gasket as sealing element.

Abbreviated designation: AG G xx and IG G xx resp. (xx stands for the relevant size)

- Other connections can be agreed separately and are described in the relevant technical documents of the product. Suitable adapters for other connections are available in the AWA product range.

- Design, function and arrangement of service connections:

Depending on the configuration, the adapter can have non-lockable (designation "B") service connections for the installation of further system components (see chapter "Operating principle").

The arrangement of the service connections is shown in the chapter "Operating principle".

In the standard version, the connection is designed as a detachable threaded fitting with a 90° sealing cone in the SAEM ¼" size and closed with a metal-sealing blind nut. Other versions, such as ODS, NPTF, CEL etc. can be supplied by agreement.

Transport and Storage

Transport the adapter by closed means of transport in the original packing protected against weather influences, and store it in a dry place.

Mounting

Principles

- The adapter shall be arranged in the system so that it can be properly operated and maintained.



DANGER!

Damage of adapter possible.
 Serious injuries and system failure possible during operation.
 Adapter to be installed without additional loads (forces, vibrations).
 Never use the adapter as fixing points of pipes.

- It is in particular necessary to provide sufficient space for the tightening of the adapter or use of service connections if necessary.
- The flow can pass the adapter in both directions.
- Only authorized personnel shall be allowed to mount the adapter.



DANGER!

Any non-observance of these instructions may cause the adapter/system to fail.
 Most serious injuries and death possible.
 Mounting and operation by personnel trained in refrigeration systems only.

- No modifications of the adapter are permitted. If modifications become necessary, they have to be agreed with the manufacturer beforehand.



WARNING!

Product features may change.
 Avoidable serious to very serious injuries or death possible.
 Any modification of the adapter has to be agreed with manufacturer in advance.

Mounting preparation

- The adapter may come with additional protective means for transport. To avoid corrosion inside the adapter and contamination, such protective means should be removed shortly before mounting.



ATTENTION!

Possible damage of interior surfaces.
 Malfunction due to oxidation/contamination of internal components.
 Remove the transport protection shortly before mounting.

- If the adapter is screwed/pre-mounted when supplied, take it apart. The seal washer must not remain on the adapter while the pipe connection is made.



ATTENTION!

Damage to seal washer / adapter components possible.
 Leakage of refrigerant.
 Remove seal washer and dismantle prior to joining!

Connecting pipe / system

- Make the connection of the inlet and the outlets in compliance with the following connection-specific principles:

The pipe must be of a dimension that fits the adapter. If not, use adapters.

Make sure there is no mechanical restraint.

- **For soldered/welded connections (connections A through B):**

Prepare the system connections so (bare metal and grease-free) that a high-quality joint can be achieved.

Scavenge the relevant pipe sections with shielding gas during soldering / welding.

Then, cool down the system connection in the air.

Clean the pipe connection made. Flux material residues from the soldering process are very corrosive and may cause long-term damage.

For stainless steel adapters observe the general rules to maintain the material properties (e.g. cleaning, passivation, tool selection).



WARNING!

Damage of adapter due to excessive heating possible.
 Serious injuries and system failure possible during operation.
 Direct the heat source away from adapter (component temperature max. 850°C)!



WARNING!

Damage of adapter (e.g. cracking) due to rapid cooling possible.
 Serious injuries and system failure possible during operation.
 Allow joint to cool down in the air.



CAUTION!

Risk of increased corrosion and component damage.
 Serious injuries and system failure possible during operation.
 Properly clean the joint after joining.



ATTENTION!

Possible damage of interior surfaces.
 Malfunction due to oxidation of internal surfaces.
 Scavenge with shielding gas while joining.

- **For screwed connections (connection C through E):**

Make sure that the connections are in conformity in terms of type and dimension and the sealing elements that may be necessary are used.

If available, use the wrench flats directly arranged at the connection to apply the necessary torques. The torques of the relevant screw connections have to be strictly observed.

Especially when it comes to stainless steel connections it is essential to observe the general technical rules to avoid fretting (use release agents).



WARNING!

Excessive torques or non-observance of the mounting order may cause failures delayed in time.
 Serious injuries and system failure possible during operation.
 Observe the torques and mounting order.

- For connection C only: Rendering flange connections

Make sure that the compressor connection is in conformity in terms of type and dimensions and that the required sealing elements are used. Mount the adapter on the compressor using the mounting material specified by the compressor manufacturer.

Initially screw the nuts/bolts hand-tight. Then tighten the nuts/bolts crosswise in at least 2 stages to the specified tightening torque.

Thread	Tightening torque (in Nm) at strength class 8.8
M8	25 ±5
M10	50 ±5
M12	100 ±10

- For connection D only: Rendering a Rotalock connection

The PTFE sealing ring matching the screw connection must be inserted into the groove of the adapter with external thread. Afterwards, the screw connection component with internal thread is first screwed hand-tight. Then tighten the Rotalock connection with the specified tightening torque.

Rotalock size	Thread	Tightening torque (in Nm)
RL 3/4"	3/4-16 UNF	30 +10
RL 1"	1-14 UNS	60 +10
RL 1 1/4"	1 1/4-12 UNF	100 +10
RL 1 1/2"	1 1/2-12 UN	125 +10
RL 1 3/4"	1 3/4-12 UN	150 +10
RL 2	2-12 UN	160 +10
RL 2 1/4"	2 1/4-12 UN	170 +10

- For connection E only: Rendering screw joints with NPTF thread

The screw connection is to be tightened with the corresponding counterpart with the following tightening torques.

Thread	Tightening torque (in Nm)
1/8-27 NPTF	10 +3
1/4-18 NPTF	20 +3
3/8-18 NPTF	42 +5
1/2-14 NPTF	60 +10

For the NPTF connection thread sealants may be used.

- For connection F only: Rendering the screw connection with cylindrical pipe thread
Mount the mating piece as specified by the component manufacturer.
- For connection variants or connection sizes not listed here, the tightening torques or a description of the installation procedure are listed in the technical documentation or in a separate supplementary sheet.
- **For service connections:**

Depending on the configuration, the adapter can have non-lockable service connections (see chapter "Description").

If necessary, use the service connections for the installation of further system components.

If available, use the wrench flats directly arranged at the connection to apply the necessary torques. The torques of the relevant screw connections have to be strictly observed.

The following torques apply to the service connection:

Connection	Torque in Nm
Connection SAE 1/4"	Cap nut 5 +5 Flare nut 14 +4
Connection 1/8-27 NPTF	15 +5

For the NPTF connection thread sealants may be used.

Commissioning

Principles

- The adapter and the system into which it is installed, may only be commissioned if they have been checked, with due regard to the intended mode of operation, for proper condition as to assembly, installation, set-up conditions and safe functioning.
- After mounting and initial start-up according to EN 378-2 check again for leakage and strength and an effective corrosion protection.

Steps of commissioning

- Check the system for leakage and resistance to pressure by suitable means (e.g. helium, dry nitrogen).

	DANGER! Danger of bursting. Most serious injuries possible. The test pressure must not exceed the maximum allowable pressure (PS). Strictly observe the safety information (e.g. EN 378).
---	--

- The application of an anticorrosive coating that suits the operating conditions is absolutely necessary for steel adapters and may be necessary for stainless steel adapters. Make sure that the manufacturer's instructions remain legible.

	CAUTION! Delayed failure due to corrosion possible. Serious injuries and failure of system during operation possible. Apply a suitable anticorrosive coat.
--	--

	ATTENTION! Loss of product conformity due to loss of lettering. Loss of warranty. Lettering must be legible.
---	--

- Evacuating and filling the system with refrigerant.

	DANGER! Danger of bursting if operated beyond the technical parameters. Most serious injuries possible. Observe the technical parameters of the adapter. Avoid excessive filling of the system with refrigerant.
---	---

- Upon initial commissioning check the pipes for any abnormal vibration and record the operating data.

	CAUTION! Cracks of the piping and the adapter due to dynamic loads possible. Injuries and system failure during operation possible. Avoid heavy vibrations. Take safety measures if need be.
---	--

Operation, Maintenance and Repair

Principles

- The adapter is maintenance-free.
- As part of the regular system inspection it should be checked for corrosion/damage/tightness and operability and its proper condition restored if necessary.

	WARNING!
	<p>Media contact possible, contact with hot/cold surfaces. Burns, frostbites. Wear personal protective equipment during maintenance and inspections as prescribed by national regulations.</p>

Handling the service connections

- Depending on the configuration, the adapter can have **non**-lockable service connections (see chapter "Operating principle").
- With this connection, **no** separation of the connection from the circuit is achieved. This means that it is only intended for use with permanently connected safety devices / pressure gauges.

	DANGER!
	<p>The non-lockable service connection pressurized permanently. Serious injury caused by loose parts and escape of greater amounts of operating fluid possible. The system should be depressurized for any work on the non-lockable service connection.</p>

Repairs

- If a repair or loosening of the screw connection is necessary, the system must be switched off, the refrigerant must be removed from the system (or system section) in an environmentally friendly manner and the system (or system section) must be ventilated.

	DANGER!
	<p>Refrigerant may escape. Leaking refrigerant may cause most serious injuries. For repairs the system must have the right temperature, free from refrigerant and sufficiently ventilated.</p>

- When screwing again, a new PTFE sealing ring must be used.
- For repairs use no other than original spare parts. If it is not possible to repair the adapter, it must be replaced.

	WARNING!
	<p>Adapter damage due to defective spare parts/mounting. Avoidable serious injuries and system failure possible. Use no other than original spare parts for repairs.</p>

- Install / commission according to these instructions. It is imperative to carry out another leakage and strength test. No warranty is accepted by AWA for tightness in case of repair.

Dismantling and Disposal

Principles

- To dismantle the adapter, shut off the system, remove the refrigerant from the system (or system section) in an environmentally friendly manner and sufficiently vent the system (or system section).



DANGER!

Refrigerant may escape.
Leaking refrigerant may cause most serious injuries.
For repairs the system must have the right temperature, free from refrigerant and sufficiently ventilated.



WARNING!

Media contact possible, contact with hot/cold surfaces.
Burns, frostbites.
Wear personal protective equipment during maintenance and inspection as prescribed by national regulations.

- The adapter and its components can be recycled:

Adapter:	steel scrap / stainless steel scrap
Flare nuts:	brass, stainless steel, aluminium
Dust cap:	plastics (PE)
PTFE-Rotalock seal:	plastics (PTFE); CAS number: 9002-84-0 (observe country-specific regulations for disposal if necessary)



Armaturenwerk Altenburg GmbH

Am Weißen Berg 30
D-04600 Altenburg
Germany

Telephone +49 (0) 3447-893-0
Telefax +49 (0) 3447-811-10

Internet: <http://www.awa-armaturenwerk.de>
E-Mail: info@awa-armaturenwerk.de

Subject to change as of: 04.2022
Document 90000717 Revision 01